

Data Sheet | Item Number: 280-606

4-conductor carrier terminal block; for DIN-rail 35 x 15 and 35 x 7.5; 2.5 mm²; CAGE CLAMP®; 2,50 mm²; gray

<https://www.wago.com/280-606>

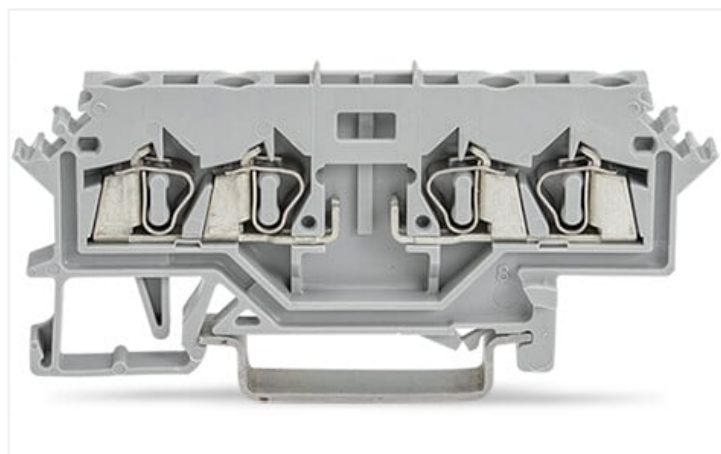
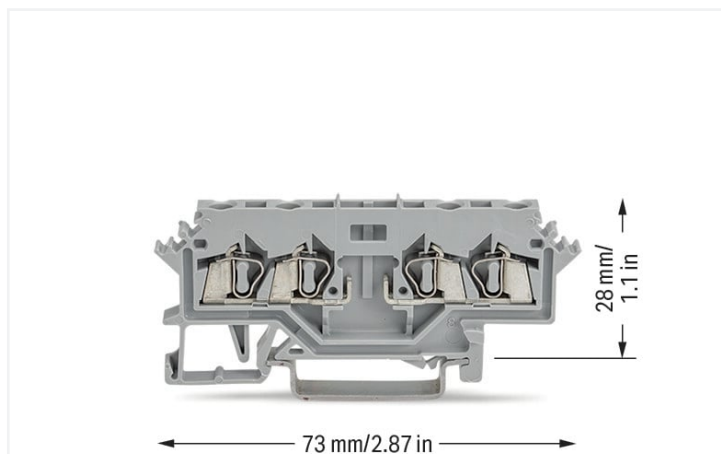

Color: ■ gray

Electrical data

Ratings per	IEC/EN 60947-7-1		
Overvoltage category	III	III	II
Pollution degree	3	2	2
Nominal voltage	400 V	-	-
Rated surge voltage	6 kV	-	-
Rated current	10 A	-	-

Power Loss

Power loss, per pole (potential)	0.133 W
Rated current I_N for specified power loss	10 A
Resistance value for specified, current-dependent power loss	0.00133 Ω

Connection data

Connection points	4
Total number of potentials	2
Number of levels	1

Connection 1

Connection technology	CAGE CLAMP®
Actuation type	Operating tool
Connectable conductor materials	Copper Aluminum

Connection 1

Connectable conductor materials (note)

Terminating Aluminum Conductors

WAGO spring clamp terminal blocks are suitable for solid aluminum conductors up to 4 mm²/12 AWG if WAGO "Alu-Plus" Contact Paste [249-130](#) is used for termination.

"Alu-Plus" Contact Paste Advantages:

- Automatically destroys the oxide film during clamping.
- Prevents fresh oxidation at the clamping point.
- Prevents electrolytic corrosion between aluminum and copper conductors (in the same terminal block).
- Provides long-term protection against corrosion.

Using terminal blocks with CAGE CLAMP® Spring Pressure Connection Technology, **aluminum conductors must first be cleaned with a blade** and then immediately be inserted into the clamping units filled with "Alu-Plus" Contact Paste.

It is also possible to apply WAGO "Alu-Plus" **additionally** on the whole surface of the aluminum conductor before termination.

Please note that the nominal currents must be adapted to the reduced conductivity of the aluminum conductors::

2.5 mm² = 16 A

4 mm² = 22 A

Solid conductor	0.08 ... 2.5 mm ² / 28 ... 14 AWG
Fine-stranded conductor	0.08 ... 2.5 mm ² / 28 ... 14 AWG
Note (conductor cross-section)	12 AWG: THHN, THWN
Strip length	8 ... 9 mm / 0.31 ... 0.35 inches
Wiring direction	Front-entry wiring

Physical data

Width	5 mm / 0.197 inches
Height	73 mm / 2.874 inches
Depth from upper-edge of DIN-rail	28 mm / 1.102 inches

Mechanical data

Design	horizontal type
Mounting type	DIN-35 rail
Marking level	Side marking

Material data

Note (material data)	Information on material specifications can be found here
Color	gray
Material group	I
Insulation material	Polyamide (PA66)
Flammability class per UL94	V0
Fire load	0.157 MJ
Weight	8.2 g

Environmental requirements

Processing temperature	-35 ... +85 °C
Continuous operating temperature	-60 ... +105 °C

Commercial data

Product Group	1 (Rail Mounted Terminal Blocks)
eCl@ss 10.0	27-14-11-20
eCl@ss 9.0	27-14-11-20
ETIM 8.0	EC000897
ETIM 7.0	EC000897
PU (SPU)	100 pcs
Packaging type	Box
Country of origin	DE
GTIN	4044918635363
Customs tariff number	85369010000

Environmental Product Compliance

RoHS Compliance Status	Compliant, No Exemption
------------------------	-------------------------

Approvals / Certificates

General approvals



Approval	Standard	Certificate Name
CCA DEKRA Certification B.V.	EN 60947	2157201.01
CSA DEKRA Certification B.V.	C22.2	1536071
UL Underwriters Laboratories Inc.	UL 1059	E45172

Declarations of conformity and manufacturer's declarations

Approval	Standard	Certificate Name
EU-Declaration of Conformity WAGO GmbH & Co. KG	-	-
UK-Declaration of Conformity WAGO GmbH & Co. KG	-	-

Approvals for marine applications



Approval	Standard	Certificate Name
ABS American Bureau of Shipping	EN 60947	20-HG1941090-PDA
BV Bureau Veritas S.A.	EN 60947	07436/F0 BV
DNV GL Det Norske Veritas, Germanischer Lloyd	-	TAE00001V2
LR Lloyds Register	EN 60947	91/20112 (E9)

Downloads

Environmental Product Compliance

Compliance Search

Environmental Product Compliance 280-606 

CAD/CAE-Data

CAD data

2D/3D Models 280-606 

CAE data

EPLAN Data Portal 280-606 

WSCAD Universe 280-606 

ZUKEN Portal 280-606 

1 Compatible Products

1.1 Required Accessories

1.1.1 End plate

1.1.1.1 End plate



Item No.: 280-316
End and intermediate plate; 2.5 mm thick; gray

Item No.: 280-317
End and intermediate plate; 2.5 mm thick; orange

1.2 Optional Accessories

1.2.1 DIN-rail

1.2.1.1 Mounting accessories



Item No.: 210-196
Aluminum carrier rail; 35 x 8.2 mm; 1.6 mm thick; 2 m long; unslotted; similar to EN 60715; silver-colored



Item No.: 210-198
Copper carrier rail; 35 x 15 mm; 2.3 mm thick; 2 m long; unslotted; according to EN 60715; copper-colored



Item No.: 210-508
Steel carrier rail; 35 x 15 mm; 1.5 mm thick; 2 m long; slotted; galvanized; similar to EN 60715; silver-colored



Item No.: 210-197
Steel carrier rail; 35 x 15 mm; 1.5 mm thick; 2 m long; slotted; similar to EN 60715; silver-colored



Item No.: 210-506
Steel carrier rail; 35 x 15 mm; 1.5 mm thick; 2 m long; unslotted; galvanized; similar to EN 60715; silver-colored



Item No.: 210-114
Steel carrier rail; 35 x 15 mm; 1.5 mm thick; 2 m long; unslotted; similar to EN 60715; silver-colored



Item No.: 210-118
Steel carrier rail; 35 x 15 mm; 2.3 mm thick; 2 m long; unslotted; according to EN 60715; silver-colored



Item No.: 210-115
Steel carrier rail; 35 x 7.5 mm; 1 mm thick; 2 m long; slotted; according to EN 60715; "Hole width 18 mm; silver-colored



Item No.: 210-112
Steel carrier rail; 35 x 7.5 mm; 1 mm thick; 2 m long; slotted; according to EN 60715; "Hole width 25 mm; silver-colored



Item No.: 210-504
Steel carrier rail; 35 x 7.5 mm; 1 mm thick; 2 m long; slotted; galvanized; according to EN 60715; silver-colored



Item No.: 210-113
Steel carrier rail; 35 x 7.5 mm; 1 mm thick; 2 m long; unslotted; according to EN 60715; silver-colored



Item No.: 210-505
Steel carrier rail; 35 x 7.5 mm; 1 mm thick; 2 m long; unslotted; galvanized; according to EN 60715; silver-colored

1.2.2 Ferrule

1.2.2.1 Ferrule



Item No.: 216-301

Ferrule; Sleeve for 0.25 mm² / AWG 24; insulated; electro-tin plated; yellow



Item No.: 216-302

Ferrule; Sleeve for 0.34 mm² / 22 AWG; insulated; electro-tin plated; light turquoise



Item No.: 216-201

Ferrule; Sleeve for 0.5 mm² / 20 AWG; insulated; electro-tin plated; white



Item No.: 216-101

Ferrule; Sleeve for 0.5 mm² / AWG 22; un-insulated; electro-tin plated; silver-colored



Item No.: 216-202

Ferrule; Sleeve for 0.75 mm² / 18 AWG; insulated; electro-tin plated; gray



Item No.: 216-102

Ferrule; Sleeve for 0.75 mm² / AWG 20; un-insulated; electro-tin plated; silver-colored



Item No.: 216-203

Ferrule; Sleeve for 1 mm² / AWG 18; insulated; electro-tin plated; red



Item No.: 216-103

Ferrule; Sleeve for 1 mm² / AWG 18; un-insulated; electro-tin plated



Item No.: 216-204

Ferrule; Sleeve for 1.5 mm² / AWG 16; insulated; electro-tin plated; black



Item No.: 216-104

Ferrule; Sleeve for 1.5 mm² / AWG 16; un-insulated; electro-tin plated; silver-colored

1.2.3 Installation

1.2.3.1 Mounting accessories



Item No.: 209-106

Mounting carrier; for isolated mounting on DIN 35 rails; gray



Item No.: 249-116

Screwless end stop; 6 mm wide; for DIN-rail 35 x 15 and 35 x 7.5; gray

1.2.4 Insulation stop

1.2.4.1 Insulation stop



Item No.: 280-470

Insulation stop; 0.08 - 0.2 mm² "s" (0.14 mm² "f-st"); 5 pieces/strip; white



Item No.: 280-471

Insulation stop; 0.25 - 0.5 mm²; 5 pieces/strip; light gray



Item No.: 280-472

Insulation stop; 0.75 - 1 mm²; 5 pieces/strip; black

1.2.5 Jumper

1.2.5.1 Jumper



Item No.: 280-490

Jumper; 10-way; insulated; gray



Item No.: 280-482

Jumper; 2-way; insulated; gray



Item No.: 280-492

Jumper; 2-way; insulated; gray



Item No.: 280-483

Jumper; 3-way; insulated; gray



Item No.: 280-484

Jumper; 4-way; insulated; gray



Item No.: 280-485

Jumper; 5-way; insulated; gray



Item No.: 709-110

Wire comming chain; 2.5 mm²; insulated; black



Item No.: 709-111

Wire comming chain; 2.5 mm²; insulated; black



Item No.: 709-112

Wire comming chain; 2.5 mm²; insulated; black



Item No.: 210-103

Wire comming chain; insulated; black



Item No.: 210-123

Wire comming chain; insulated; blue

1.2.6 Marking

1.2.6.1 Marker



Item No.: 793-5501/000-006

WMB marking card; as card; for terminal block width 5 - 17.5 mm; stretchable 5 - 5.2 mm; plain; snap-on type; blue



Item No.: 793-5501/000-007

WMB marking card; as card; for terminal block width 5 - 17.5 mm; stretchable 5 - 5.2 mm; plain; snap-on type; gray



Item No.: 793-5501/000-023

WMB marking card; as card; for terminal block width 5 - 17.5 mm; stretchable 5 - 5.2 mm; plain; snap-on type; green



Item No.: 793-5501/000-017

WMB marking card; as card; for terminal block width 5 - 17.5 mm; stretchable 5 - 5.2 mm; plain; snap-on type; light green



Item No.: 793-5501/000-012

WMB marking card; as card; for terminal block width 5 - 17.5 mm; stretchable 5 - 5.2 mm; plain; snap-on type; orange



Item No.: 793-5501/000-005

WMB marking card; as card; for terminal block width 5 - 17.5 mm; stretchable 5 - 5.2 mm; plain; snap-on type; red



Item No.: 793-5501/000-024

WMB marking card; as card; for terminal block width 5 - 17.5 mm; stretchable 5 - 5.2 mm; plain; snap-on type; violet



Item No.: 793-5501

WMB marking card; as card; for terminal block width 5 - 17.5 mm; stretchable 5 - 5.2 mm; plain; snap-on type; white



Item No.: 793-5501/000-002

WMB marking card; as card; for terminal block width 5 - 17.5 mm; stretchable 5 - 5.2 mm; plain; snap-on type; yellow



Item No.: 793-501/000-006

WMB marking card; as card; not stretchable; plain; snap-on type; blue



Item No.: 793-501/000-007

WMB marking card; as card; not stretchable; plain; snap-on type; gray



Item No.: 793-501/000-023

WMB marking card; as card; not stretchable; plain; snap-on type; green



Item No.: 793-501/000-017

WMB marking card; as card; not stretchable; plain; snap-on type; light green



Item No.: 793-501/000-012

WMB marking card; as card; not stretchable; plain; snap-on type; orange



Item No.: 793-501/000-005

WMB marking card; as card; not stretchable; plain; snap-on type; red



Item No.: 793-501/000-024

WMB marking card; as card; not stretchable; plain; snap-on type; violet



Item No.: 793-501

WMB marking card; as card; not stretchable; plain; snap-on type; white



Item No.: 793-501/000-002

WMB marking card; as card; not stretchable; plain; snap-on type; yellow



Item No.: 2009-115/000-006

WMB-Inline; for Smart Printer; 1500 pieces on roll; stretchable 5 - 5.2 mm; plain; snap-on type; blue



Item No.: 2009-115/000-007

WMB-Inline; for Smart Printer; 1500 pieces on roll; stretchable 5 - 5.2 mm; plain; snap-on type; gray



Item No.: 2009-115/000-023

WMB-Inline; for Smart Printer; 1500 pieces on roll; stretchable 5 - 5.2 mm; plain; snap-on type; green



Item No.: 2009-115/000-017

WMB-Inline; for Smart Printer; 1500 pieces on roll; stretchable 5 - 5.2 mm; plain; snap-on type; light green



Item No.: 2009-115/000-012

WMB-Inline; for Smart Printer; 1500 pieces on roll; stretchable 5 - 5.2 mm; plain; snap-on type; orange



Item No.: 2009-115/000-024

WMB-Inline; for Smart Printer; 1500 pieces on roll; stretchable 5 - 5.2 mm; plain; snap-on type; violet



Item No.: 2009-115

WMB-Inline; for Smart Printer; 1500 pieces on roll; stretchable 5 - 5.2 mm; plain; snap-on type; white



Item No.: 2009-115/000-002

WMB-Inline; for Smart Printer; 1500 pieces on roll; stretchable 5 - 5.2 mm; plain; snap-on type; yellow

1.2.7 Plug

1.2.7.1 AND gate module



Item No.: 286-826

AND gate module with 6 inputs; light gray

1.2.7.2 Bridge rectifier module



Item No.: 286-830

Bridge rectifier module; Input voltage: 24 VAC; with varistor protective circuit; gray

1.2.7.3 Component module with a fuse



Item No.: 286-891

Component module with fuse; for (5 x 20) mm microfuse; Nominal voltage: 230 VAC/DC; gray



Item No.: 286-890

Component module with fuse; for (5 x 20) mm microfuse; Nominal voltage: 24 VAC/DC; gray

1.2.7.4 Component module with diode



Item No.: 286-805

Component module with diode; with 5 pcs; Diode 1N4007; with common anode; gray



Item No.: 286-807

Component module with diode; with 7 pcs; Diode 1N4007; with common anode; gray



Item No.: 286-809

Component module with diode; with 9 pcs; Diode 1N4007; with common anode; gray



Item No.: 280-801/281-411

Component plug; for carrier terminal blocks; 2-pole; with diode 1N4007; 5 mm wide; gray



Item No.: 280-801/281-420

Component plug; for carrier terminal blocks; 2-pole; with LED and recovery diode; 5 mm wide; gray



Item No.: 280-801/281-421

Component plug; for carrier terminal blocks; 2-pole; with LED and recovery diode; 5 mm wide; gray

1.2.7.5 Component module with LED



Item No.: 286-822

Component module with LED; Red LED; with common cathode



Item No.: 280-801/281-413

Component plug; for carrier terminal blocks; 2-pole; LED (red); 24 VDC; 5 mm wide; gray



Item No.: 280-801/281-414

Component plug; for carrier terminal blocks; 2-pole; LED (red); 48 VDC; 5 mm wide; gray



Item No.: 280-801/281-416

Component plug; for carrier terminal blocks; 2-pole; LED (red); 5 mm wide; gray



Item No.: 280-801/281-420

Component plug; for carrier terminal blocks; 2-pole; with LED and recovery diode; 5 mm wide; gray



Item No.: 280-801/281-421

Component plug; for carrier terminal blocks; 2-pole; with LED and recovery diode; 5 mm wide; gray

1.2.7.6 Component Terminal Block with LED



Item No.: 280-801/281-415

Component plug; for carrier terminal blocks; 2-pole; LED (red); 5 mm wide; gray

1.2.7.7 Current flow monitoring module



Item No.: 286-661

Current flow monitoring module; AC currents; light gray



Item No.: 286-664

Current flow monitoring module; AC currents; Monitoring range: 0.2 A – 3 A; 1 changeover contact; light gray



Item No.: 286-665

Current flow monitoring module; AC currents; Monitoring range: 1 A – 10 A; 1 changeover contact; light gray



Item No.: 286-662

Current flow monitoring module; DC currents; Monitoring range: 0.4 A – 3.5 A; 1 make contact; light gray

1.2.7.8 Empty component plug housing



Item No.: 280-804
Empty component plug housing; 10 mm wide; Type 3; 4-pole; gray



Item No.: 280-801
Empty component plug housing; gray



Item No.: 280-802
Empty component plug housing; gray



Item No.: 286-111
Empty component plug housing; Type 10; 15 mm wide; 6-pole; gray



Item No.: 286-112
Empty component plug housing; Type 11; 20 mm wide; 8-pole; gray



Item No.: 286-113
Empty component plug housing; Type 12; 25 mm wide; 10-pole; gray



Item No.: 286-110
Empty component plug housing; Type 9; 10 mm wide; 4-pole; gray

1.2.7.9 Fuse plug



Item No.: 281-512/281-418
Fuse plug; with pull-tab; for miniature metric fuses 5 x 20 mm and 5 x 25 mm; with blown fuse indication by neon lamp; 120 V; 6 mm wide; gray



Item No.: 281-512/281-417
Fuse plug; with pull-tab; for miniature metric fuses 5 x 20 mm and 5 x 25 mm; with blown fuse indication by neon lamp; 230 V; 6 mm wide; gray



Item No.: 281-512/281-501
Fuse plug; with pull-tab; for miniature metric fuses 5 x 20 mm and 5 x 25 mm; with LED indicator; 24 V AC/DC; 6 mm wide; gray



Item No.: 281-512
Fuse plug; with pull-tab; for miniature metric fuses 5 x 20 mm and 5 x 25 mm; with port for LED; 6 mm wide; gray



Item No.: 281-511
Fuse plug; with pull-tab; for miniature metric fuses 5 x 20 mm and 5 x 25 mm; without blown fuse indication; 6 mm wide; gray



Item No.: 280-854
Fuse plug; with soldered miniature fuse; 1 A FF; 5 mm wide; gray



Item No.: 280-856
Fuse plug; with soldered miniature fuse; 2 A FF; 5 mm wide; gray



Item No.: 280-850
Fuse plug; with soldered miniature fuse; 250 mA FF; 5 mm wide; gray



Item No.: 280-852
Fuse plug; with soldered miniature fuse; 500 mA FF; 5 mm wide; gray



Item No.: 280-854/281-415
Fuse plug; with soldered miniature fuse; with indicator lamp; LED (red); AC 15 - 30 V; 1 A FF; 5 mm wide; gray



Item No.: 280-856/281-415
Fuse plug; with soldered miniature fuse; with indicator lamp; LED (red); AC 15 - 30 V; 2 A FF; 5 mm wide; gray



Item No.: 280-850/281-415
Fuse plug; with soldered miniature fuse; with indicator lamp; LED (red); AC 15 - 30 V; 250 mA FF; 5 mm wide; gray



Item No.: 280-852/281-415
Fuse plug; with soldered miniature fuse; with indicator lamp; LED (red); AC 15 - 30 V; 500 mA FF; 5 mm wide; gray



Item No.: 280-854/281-413
Fuse plug; with soldered miniature fuse; with indicator lamp; LED (red); DC 15 - 30 V; 1 A FF; 5 mm wide; gray



Item No.: 280-856/281-413
Fuse plug; with soldered miniature fuse; with indicator lamp; LED (red); DC 15 - 30 V; 2 A FF; 5 mm wide; gray



Item No.: 280-850/281-413
Fuse plug; with soldered miniature fuse; with indicator lamp; LED (red); DC 15 - 30 V; 250 mA FF; 5 mm wide; gray



Item No.: 280-852/281-413
Fuse plug; with soldered miniature fuse; with indicator lamp; LED (red); DC 15 - 30 V; 500 mA FF; 5 mm wide; gray



Item No.: 280-854/281-414
Fuse plug; with soldered miniature fuse; with indicator lamp; LED (red); DC 30 - 65 V; 1 A FF; 5 mm wide; gray



Item No.: 280-856/281-414
Fuse plug; with soldered miniature fuse; with indicator lamp; LED (red); DC 30 - 65 V; 2 A FF; 5 mm wide; gray



Item No.: 280-850/281-414
Fuse plug; with soldered miniature fuse; with indicator lamp; LED (red); DC 30 - 65 V; 250 mA FF; 5 mm wide; gray



Item No.: 280-852/281-414
Fuse plug; with soldered miniature fuse; with indicator lamp; LED (red); DC 30 - 65 V; 500 mA FF; 5 mm wide; gray

1.2.7.10 Neon indicator module











Item No.: 280-801/281-417
Component plug; for carrier terminal blocks; 2-pole; 5 mm wide; gray



























Item No.: 280-801/281-418
Component plug; for carrier terminal blocks; 2-pole; 5 mm wide; gray

1.2.7.11 Optocoupler module

 <p>Item No.: 286-725 Optocoupler module; gray</p>	 <p>Item No.: 286-790 Optocoupler module; Nominal input voltage: 24 VDC; Output voltage range: 0 ... 30 VDC; Limiting continuous current: 0.5 A; gray</p>	 <p>Item No.: 286-723 Optocoupler module; Nominal input voltage: 24 VDC; Output voltage range: 15 ... 30 VDC; Limiting continuous current: 4 A; 3-wire connection/high-side switching; Red status indicator; Module width: 15 mm; gray</p>	 <p>Item No.: 286-721 Optocoupler module; Nominal input voltage: 24 VDC; Output voltage range: 15 ... 30 VDC; Limiting continuous current: 5 A; 3-wire connection/low-side switching; Red status indicator; Module width: 15 mm; gray</p>
 <p>Item No.: 286-752 Optocoupler module; Nominal input voltage: 24 VDC; Output voltage range: 20 ... 30 VDC; Limiting continuous current: 0.5 A; 3-wire connection/high-side switching; Frequency: 25 kHz; Red status indicator; Module width: 15 mm; gray</p>	 <p>Item No.: 286-791 Optocoupler module; Nominal input voltage: 24 VDC; Output voltage range: 20 ... 60 VDC; Limiting continuous current: 0.1 A; 2-wire connection; Frequency: 3 kHz; Red status indicator; Module width: 10 mm; gray</p>	 <p>Item No.: 286-794 Optocoupler module; Nominal input voltage: 24 VDC; Red status indicator; gray</p>	 <p>Item No.: 286-752/002-000 Optocoupler module; Red status indicator; gray</p>
 <p>Item No.: 286-792 Optocoupler module; Red status indicator; gray</p>			

1.2.7.12 Relay module

 <p>Item No.: 286-380 Bistable relay module; Nominal input voltage: 24 VDC; 1 changeover contact; Limiting continuous current: 6 A; Red status indicator; Module width: 15 mm; gray</p>	 <p>Item No.: 286-573 Latching relay module; Nominal input voltage: 24 VDC; 1 changeover contact; Limiting continuous current: 6 A; Red status indicator; Module width: 15 mm</p>	 <p>Item No.: 286-307/004-000 Relay module; Nominal input voltage: 110 VDC; 1 changeover contact; Limiting continuous current: 3 A; Railway; Red status indicator; Module width: 15 mm; gray</p>	 <p>Item No.: 286-507 Relay module; Nominal input voltage: 115 VAC; 1 changeover contact; Limiting continuous current: 7 A; Red status indicator; Module width: 15 mm; gray</p>
 <p>Item No.: 286-316 Relay module; Nominal input voltage: 220 VDC; 2 changeover contacts; Limiting continuous current: 7 A; Red status indicator; Module width: 20 mm; gray</p>	 <p>Item No.: 286-508 Relay module; Nominal input voltage: 230 VAC; 1 changeover contact; Limiting continuous current: 7 A; Red status indicator; Module width: 15 mm; gray</p>	 <p>Item No.: 286-516 Relay module; Nominal input voltage: 230 VAC; 2 changeover contacts; Limiting continuous current: 7 A; Red status indicator; Module width: 15 mm; gray</p>	 <p>Item No.: 286-320 Relay module; Nominal input voltage: 24 VDC; 1 break and 1 make contact; Limiting continuous current: 6 A; Red status indicator; Module width: 20 mm; gray</p>
 <p>Item No.: 286-320/004-000 Relay module; Nominal input voltage: 24 VDC; 1 break and 1 make contact; Railway; Red status indicator; Module width: 20 mm; gray</p>	 <p>Item No.: 286-368/004-000 Relay module; Nominal input voltage: 24 VDC; 1 break contact; Limiting continuous current: 3 A; Railway; Red status indicator; Module width: 10 mm; gray</p>	 <p>Item No.: 286-368 Relay module; Nominal input voltage: 24 VDC; 1 break contact; Limiting continuous current: 5 A; Red status indicator; Module width: 10 mm; gray</p>	 <p>Item No.: 286-394/004-000 Relay module; Nominal input voltage: 24 VDC; 1 changeover contact; Limiting continuous current: 1 A; with gold contacts; Railway; Red status indicator; Module width: 15 mm; light gray</p>
 <p>Item No.: 286-304/004-000 Relay module; Nominal input voltage: 24 VDC; 1 changeover contact; Limiting continuous current: 6 A; Railway; Red status indicator; Module width: 15 mm; gray</p>	 <p>Item No.: 286-304 Relay module; Nominal input voltage: 24 VDC; 1 changeover contact; Limiting continuous current: 7 A; Red status indicator; Module width: 15 mm; gray</p>	 <p>Item No.: 286-364/004-000 Relay module; Nominal input voltage: 24 VDC; 1 make contact; Limiting continuous current: 3 A; Railway; Red status indicator; Module width: 10 mm; gray</p>	 <p>Item No.: 286-376 Relay module; Nominal input voltage: 24 VDC; 1 make contact; Limiting continuous current: 5 A; for switching higher DC loads; Red status indicator; Module width: 15 mm; gray</p>
 <p>Item No.: 286-364 Relay module; Nominal input voltage: 24 VDC; 1 make contact; Limiting continuous current: 5 A; Red status indicator; Module width: 10 mm; gray</p>	 <p>Item No.: 286-336/001-000 Relay module; Nominal input voltage: 24 VDC; 2 break and 2 make contacts; Red status indicator; Module width: 25 mm; gray</p>	 <p>Item No.: 286-312/004-000 Relay module; Nominal input voltage: 24 VDC; 2 changeover contacts; Limiting continuous current: 5 A; Railway; Red status indicator; Module width: 20 mm; gray</p>	 <p>Item No.: 286-312 Relay module; Nominal input voltage: 24 VDC; 2 changeover contacts; Limiting continuous current: 7 A; Red status indicator; Module width: 20 mm; gray</p>
 <p>Item No.: 286-328/004-000 Relay module; Nominal input voltage: 24 VDC; 2 make contact; Limiting continuous current: 6 A; Railway; Red status indicator; Module width: 20 mm; gray</p>	 <p>Item No.: 286-328 Relay module; Nominal input voltage: 24 VDC; 2 make contact; Limiting continuous current: 6 A; Red status indicator; Module width: 20 mm; gray</p>	 <p>Item No.: 286-344/004-000 Relay module; Nominal input voltage: 24 VDC; 3 break contacts and 1 make contact; Railway; Red status indicator; Module width: 25 mm; gray</p>	 <p>Item No.: 286-352/004-000 Relay module; Nominal input voltage: 24 VDC; 4 make contacts; Limiting continuous current: 5 A; Railway; Red status indicator; Module width: 25 mm; gray</p>

1.2.7.12 Relay module



Item No.: 286-640/004-000

Timer relay module; Nominal input voltage: 24 VDC; Limiting continuous current: 5 A; Railway; Multifunction; Red status indicator; Module width: 20 mm; gray

Item No.: 286-604/004-000

Timer relay module; Nominal input voltage: 24 VDC; Limiting continuous current: 6 A; On-delay: 10 ... 100 s; Red status indicator; Module width: 20 mm; gray

Item No.: 286-640

Timer relay module; Nominal input voltage: 24 VDC; Limiting continuous current: 6 A; Railway; Multifunction/Multitime; Red status indicator; Module width: 20 mm; gray

1.2.7.13 S0 interface power supply unit



Item No.: 286-742

S0 interface power supply; Input voltage: 230 VAC; S0 interface

1.2.7.14 Switching module



Item No.: 286-895

Switching module; with changeover rocker switch; Switching voltage: 250 VAC; Switching current: 6 A; gray

Item No.: 286-896

Switching module; with momentary switch; Switching voltage: 250 VAC; Switching current: 6 A; gray

1.2.7.15 Timer relay module



Item No.: 286-640/004-000

Timer relay module; Nominal input voltage: 24 VDC; Limiting continuous current: 5 A; Railway; Multifunction; Red status indicator; Module width: 20 mm; gray

Item No.: 286-604/004-000

Timer relay module; Nominal input voltage: 24 VDC; Limiting continuous current: 6 A; On-delay: 10 ... 100 s; Red status indicator; Module width: 20 mm; gray

Item No.: 286-640

Timer relay module; Nominal input voltage: 24 VDC; Limiting continuous current: 6 A; Railway; Multifunction/Multitime; Red status indicator; Module width: 20 mm; gray

1.2.8 Protective warning marker

1.2.8.1 Cover



Item No.: 280-415

Protective warning marker; for 5 terminal blocks; with high-voltage symbol, black; yellow

1.2.9 Tool

1.2.9.1 Operating tool



Item No.: 210-658

Operating tool; Blade: 3.5 x 0.5 mm; with a partially insulated shaft; angled; short; multicoloured

Item No.: 210-720

Operating tool; Blade: 3.5 x 0.5 mm; with a partially insulated shaft; multicoloured

Item No.: 210-657

Operating tool; Blade: 3.5 x 0.5 mm; with a partially insulated shaft; short; multicoloured