

## Data Sheet | Item Number: 249-116

Screwless end stop; 6 mm wide; for DIN-rail 35 x 15 and 35 x 7.5; gray

<https://www.wago.com/249-116>

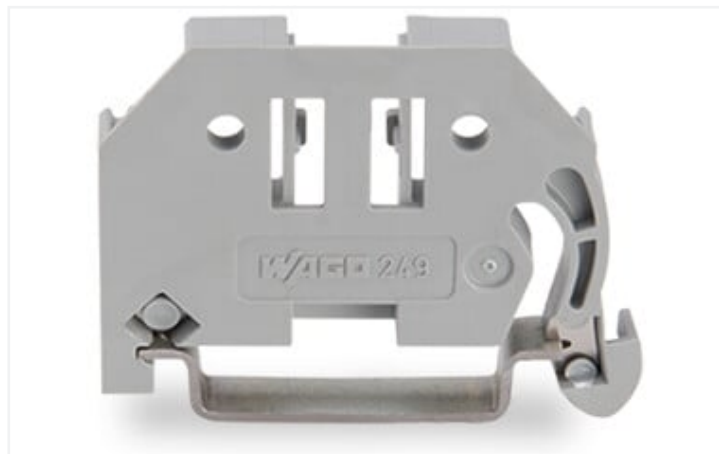
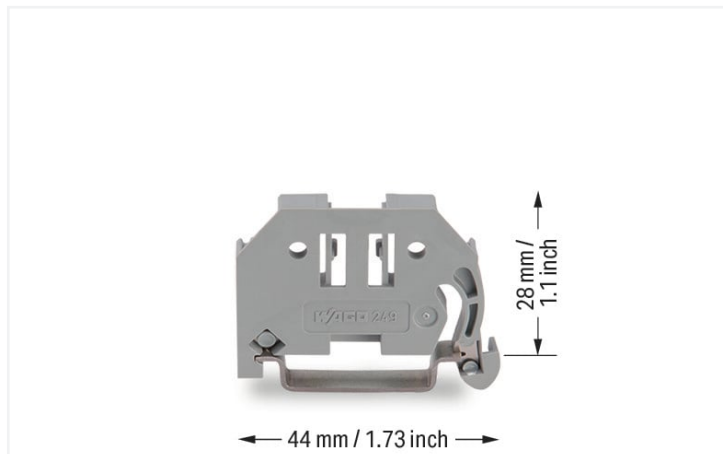

Color: ■ gray

### Notes

Note

#### Snap on – that's it!

Assembling the new WAGO screwless end stop is as simple and quick as snapping a WAGO rail-mount terminal block onto the rail.

#### Tool free!

A tool-free design allows rail-mount terminal blocks to be safely and economically secured against any movement on all DIN-35 rails per DIN EN 60715 (35 x 7.5 mm; 35 x 15 mm).

#### Entirely without screws!

The "secret" to a perfect fit lies in the two small clamping plates which keep the end stop in position, even if the rails are mounted vertically.

#### Simply snap on – that's it!

In addition, costs are significantly reduced when using large numbers of end stops. Additional benefit: Three marker slots for all WAGO rail-mount terminal block markers and one snap-in hole for WAGO adjustable height group marker carriers offer individual marking options.

### Technical data

Mounting type DIN-35 rail

### Physical data

Width 6 mm / 0.236 inches  
Height 44 mm / 1.732 inches  
Depth 35 mm / 1.378 inches  
Depth from upper-edge of DIN-rail 28 mm / 1.102 inches

### Material data

Color gray  
Insulation material Polyamide (PA66)  
Flammability class per UL94 V0  
Fire load 0.104 MJ  
Weight 3.4 g



**Commercial data**

Product Group	2 (Terminal Block Accessories)
eCl@ss 10.0	27-14-11-35
eCl@ss 9.0	27-14-11-35
ETIM 8.0	EC001041
ETIM 7.0	EC001041
PU (SPU)	100 (25) pcs
Packaging type	Box
Country of origin	DE
GTIN	4017332270823
Customs tariff number	39269097900

**Environmental Product Compliance**

RoHS Compliance Status	Compliant, No Exemption
------------------------	-------------------------

**Downloads**

**Environmental Product Compliance**

**Compliance Search**

Environmental Product Compliance 249-116	<a href="#">↓</a>
--	-------------------

**Documentation**

**Bid Text**

249-116	19.02.2019	xml 2.66 KB	<a href="#">↓</a>
249-116	31.08.2017	doc 23.50 KB	<a href="#">↓</a>

**CAD/CAE-Data**

**CAD data**

2D/3D Models 249-116	<a href="#">↓</a>
----------------------	-------------------

**CAE data**











EPLAN Data Portal 249-116	<a href="#">↓</a>
WSCAD Universe 249-116	<a href="#">↓</a>
ZUKEN Portal 249-116	<a href="#">↓</a>

**1 Compatible Products**



**1.1 Optional Accessories**

**1.1.1 Marking**

























**1.1.1.1 Group marker carrier**

			
<a href="#">Item No.: 2009-163</a> Group marker carrier; gray	<a href="#">Item No.: 209-140</a> Group marker carrier; gray	<a href="#">Item No.: 209-141</a> Group marker carrier; gray	<a href="#">Item No.: 209-142</a> Group marker carrier; gray
			
<a href="#">Item No.: 249-105</a> Group marker carrier; gray	<a href="#">Item No.: 249-118</a> Group marker carrier; gray	<a href="#">Item No.: 249-119</a> Group marker carrier; gray	<a href="#">Item No.: 709-118</a> Group marker carrier; gray
			
<a href="#">Item No.: 709-119</a> Group marker carrier; gray	<a href="#">Item No.: 209-112</a> Group marker carrier; white	<a href="#">Item No.: 249-120</a> Group marker carrier; white	

















**1.1.1.2 Label**

	
<a href="#">Item No.: 210-808</a> Labels; for Smart Printer; 9.5 x 25 mm; white	<a href="#">Item No.: 210-708</a> Labels; for TP printers; 9.5 x 25 mm; white

**1.1.1.3 Marker**

			
<a href="#">Item No.: 2009-145/000-006</a> Mini-WSB Inline; for Smart Printer; 1700 pieces on roll; stretchable 5 - 5.2 mm; plain; snap-on type; blue	<a href="#">Item No.: 2009-145/000-007</a> Mini-WSB Inline; for Smart Printer; 1700 pieces on roll; stretchable 5 - 5.2 mm; plain; snap-on type; gray	<a href="#">Item No.: 2009-145/000-023</a> Mini-WSB Inline; for Smart Printer; 1700 pieces on roll; stretchable 5 - 5.2 mm; plain; snap-on type; green	<a href="#">Item No.: 2009-145/000-012</a> Mini-WSB Inline; for Smart Printer; 1700 pieces on roll; stretchable 5 - 5.2 mm; plain; snap-on type; orange
			
<a href="#">Item No.: 2009-145/000-005</a> Mini-WSB Inline; for Smart Printer; 1700 pieces on roll; stretchable 5 - 5.2 mm; plain; snap-on type; red	<a href="#">Item No.: 2009-145/000-024</a> Mini-WSB Inline; for Smart Printer; 1700 pieces on roll; stretchable 5 - 5.2 mm; plain; snap-on type; violet	<a href="#">Item No.: 2009-145</a> Mini-WSB Inline; for Smart Printer; 1700 pieces on roll; stretchable 5 - 5.2 mm; plain; snap-on type; white	<a href="#">Item No.: 2009-145/000-002</a> Mini-WSB Inline; for Smart Printer; 1700 pieces on roll; stretchable 5 - 5.2 mm; plain; snap-on type; yellow
			
<a href="#">Item No.: 248-501/000-006</a> Mini-WSB marking card; as card; not stretchable; plain; snap-on type; blue	<a href="#">Item No.: 248-501/000-007</a> Mini-WSB marking card; as card; not stretchable; plain; snap-on type; gray	<a href="#">Item No.: 248-501/000-023</a> Mini-WSB marking card; as card; not stretchable; plain; snap-on type; green	<a href="#">Item No.: 248-501/000-017</a> Mini-WSB marking card; as card; not stretchable; plain; snap-on type; light green
			
<a href="#">Item No.: 248-501/000-012</a> Mini-WSB marking card; as card; not stretchable; plain; snap-on type; orange	<a href="#">Item No.: 248-501/000-005</a> Mini-WSB marking card; as card; not stretchable; plain; snap-on type; red	<a href="#">Item No.: 248-501/000-024</a> Mini-WSB marking card; as card; not stretchable; plain; snap-on type; violet	<a href="#">Item No.: 248-501</a> Mini-WSB marking card; as card; not stretchable; plain; snap-on type; white
			
<a href="#">Item No.: 248-501/000-002</a> Mini-WSB marking card; as card; not stretchable; plain; snap-on type; yellow	<a href="#">Item No.: 793-5501/000-006</a> WMB marking card; as card; for terminal block width 5 - 17.5 mm; stretchable 5 - 5.2 mm; plain; snap-on type; blue	<a href="#">Item No.: 793-5501/000-007</a> WMB marking card; as card; for terminal block width 5 - 17.5 mm; stretchable 5 - 5.2 mm; plain; snap-on type; gray	<a href="#">Item No.: 793-5501/000-023</a> WMB marking card; as card; for terminal block width 5 - 17.5 mm; stretchable 5 - 5.2 mm; plain; snap-on type; green
			
<a href="#">Item No.: 793-5501/000-017</a> WMB marking card; as card; for terminal block width 5 - 17.5 mm; stretchable 5 - 5.2 mm; plain; snap-on type; light green	<a href="#">Item No.: 793-5501/000-012</a> WMB marking card; as card; for terminal block width 5 - 17.5 mm; stretchable 5 - 5.2 mm; plain; snap-on type; orange	<a href="#">Item No.: 793-5501/000-005</a> WMB marking card; as card; for terminal block width 5 - 17.5 mm; stretchable 5 - 5.2 mm; plain; snap-on type; red	<a href="#">Item No.: 793-5501/000-024</a> WMB marking card; as card; for terminal block width 5 - 17.5 mm; stretchable 5 - 5.2 mm; plain; snap-on type; violet

1.1.1.3 Marker

 <p><b>Item No.: 793-5501</b> WMB marking card; as card; for terminal block width 5 - 17.5 mm; stretchable 5 - 5.2 mm; plain; snap-on type; white</p>	 <p><b>Item No.: 793-5501/000-002</b> WMB marking card; as card; for terminal block width 5 - 17.5 mm; stretchable 5 - 5.2 mm; plain; snap-on type; yellow</p>	 <p><b>Item No.: 793-501/000-006</b> WMB marking card; as card; not stretchable; plain; snap-on type; blue</p>	 <p><b>Item No.: 793-501/000-007</b> WMB marking card; as card; not stretchable; plain; snap-on type; gray</p>
 <p><b>Item No.: 793-501/000-023</b> WMB marking card; as card; not stretchable; plain; snap-on type; green</p>	 <p><b>Item No.: 793-501/000-017</b> WMB marking card; as card; not stretchable; plain; snap-on type; light green</p>	 <p><b>Item No.: 793-501/000-012</b> WMB marking card; as card; not stretchable; plain; snap-on type; orange</p>	 <p><b>Item No.: 793-501/000-005</b> WMB marking card; as card; not stretchable; plain; snap-on type; red</p>
 <p><b>Item No.: 793-501/000-024</b> WMB marking card; as card; not stretchable; plain; snap-on type; violet</p>	 <p><b>Item No.: 793-501</b> WMB marking card; as card; not stretchable; plain; snap-on type; white</p>	 <p><b>Item No.: 793-501/000-002</b> WMB marking card; as card; not stretchable; plain; snap-on type; yellow</p>	 <p><b>Item No.: 2009-115/000-006</b> WMB-Inline; for Smart Printer; 1500 pieces on roll; stretchable 5 - 5.2 mm; plain; snap-on type; blue</p>
 <p><b>Item No.: 2009-115/000-007</b> WMB-Inline; for Smart Printer; 1500 pieces on roll; stretchable 5 - 5.2 mm; plain; snap-on type; gray</p>	 <p><b>Item No.: 2009-115/000-023</b> WMB-Inline; for Smart Printer; 1500 pieces on roll; stretchable 5 - 5.2 mm; plain; snap-on type; green</p>	 <p><b>Item No.: 2009-115/000-017</b> WMB-Inline; for Smart Printer; 1500 pieces on roll; stretchable 5 - 5.2 mm; plain; snap-on type; light green</p>	 <p><b>Item No.: 2009-115/000-012</b> WMB-Inline; for Smart Printer; 1500 pieces on roll; stretchable 5 - 5.2 mm; plain; snap-on type; orange</p>
 <p><b>Item No.: 2009-115/000-024</b> WMB-Inline; for Smart Printer; 1500 pieces on roll; stretchable 5 - 5.2 mm; plain; snap-on type; violet</p>	 <p><b>Item No.: 2009-115</b> WMB-Inline; for Smart Printer; 1500 pieces on roll; stretchable 5 - 5.2 mm; plain; snap-on type; white</p>	 <p><b>Item No.: 2009-115/000-002</b> WMB-Inline; for Smart Printer; 1500 pieces on roll; stretchable 5 - 5.2 mm; plain; snap-on type; yellow</p>	

Installation Notes

Installation

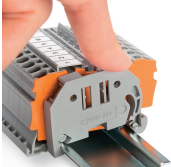
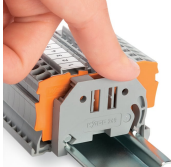
			
<p>Snap-on mounting</p>		<p>That's it!</p>	<p>Removing an end stop from the DIN-rail.</p>