

# |: 249-116

Screwless end stop; 6 mm wide; for DIN-rail 35 x 15 and 35 x 7.5; gray

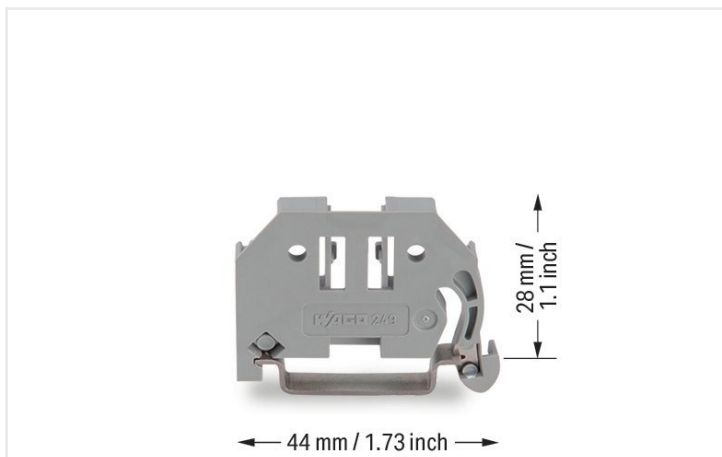

<https://www.wago.com/249-116>



: ■ gray

## Notes

### Note

#### Snap on – that's it!

Assembling the new WAGO screwless end stop is as simple and quick as snapping a WAGO rail-mount terminal block onto the rail.

#### Tool free!

A tool-free design allows rail-mount terminal blocks to be safely and economically secured against any movement on all DIN-35 rails per DIN EN 60715 (35 x 7.5 mm; 35 x 15 mm).

#### Entirely without screws!

The "secret" to a perfect fit lies in the two small clamping plates which keep the end stop in position, even if the rails are mounted vertically.

#### Simply snap on – that's it!

In addition, costs are significantly reduced when using large numbers of end stops. Additional benefit: Three marker slots for all WAGO rail-mount terminal block markers and one snap-in hole for WAGO adjustable height group marker carriers offer individual marking options.

## Technical data

Main product function	Mounting accessories
Mounting type	DIN-35 rail

## Physical data

Width	6 mm / 0.236 inches
Height	44 mm / 1.732 inches
Depth	35 mm / 1.378 inches
Depth from upper-edge of DIN-rail	28 mm / 1.102 inches

## Material data

Color	gray
Insulation material	Polyamide (PA66)
Flammability class per UL94	V0
Fire load	0.104 MJ
Weight	3.5 g

## Commercial data

Product Group	2 (Terminal Block Accessories)
eCl@ss 10.0	27-14-11-35
eCl@ss 9.0	27-14-11-35
ETIM 8.0	EC001041
ETIM 7.0	EC001041
PU (SPU)	100 (25) Stück
Packaging type	Box
Country of origin VKOrg Germany	CN
GTIN	4017332270823
Customs tariff number VKOrg Germany	39269097900

## Downloads

### Environmental Product Compliance

#### Compliance Search

Environmental Product  
Compliance 249-116



## Documentation

### Bid Text

249-116	19.02.2019	xml 2.66 KB	
249-116	31.08.2017	doc 23.50 KB	

## CAD/CAE-Data

### CAD data

2D/3D Models 249-116



### CAE data

EPLAN Data Portal  
249-116



WSCAD Universe  
249-116



ZUKEN Portal 249-116



**1 Compatible products**



**1.1 Optional accessories**

**1.1.1 Marking**

























**1.1.1.1 Group marker carrier**

 : 2009-163 Group marker carrier; gray	 : 209-140 Group marker carrier; gray	 : 209-141 Group marker carrier; gray	 : 209-142 Group marker carrier; gray
 : 249-105 Group marker carrier; gray	 : 249-118 Group marker carrier; gray	 : 249-119 Group marker carrier; gray	 : 709-118 Group marker carrier; gray
 : 709-119 Group marker carrier; gray	 : 209-112 Group marker carrier; white	 : 249-120 Group marker carrier; white	

**1.1.1.2 Label**

 : 210-808 Labels; for Smart Printer; 9.5 x 25 mm; white	 : 210-708 Labels; for TP printers; 9.5 x 25 mm; white
---	---

**1.1.1.3 Marker**

 : 2009-145/000-006 Mini-WSB Inline; for Smart Printer; 1700 pieces on roll; stretchable 5 - 5.2 mm; plain; snap-on type; blue	 : 2009-145/000-007 Mini-WSB Inline; for Smart Printer; 1700 pieces on roll; stretchable 5 - 5.2 mm; plain; snap-on type; gray	 : 2009-145/000-023 Mini-WSB Inline; for Smart Printer; 1700 pieces on roll; stretchable 5 - 5.2 mm; plain; snap-on type; green	 : 2009-145/000-012 Mini-WSB Inline; for Smart Printer; 1700 pieces on roll; stretchable 5 - 5.2 mm; plain; snap-on type; orange
 : 2009-145/000-005 Mini-WSB Inline; for Smart Printer; 1700 pieces on roll; stretchable 5 - 5.2 mm; plain; snap-on type; red	 : 2009-145/000-024 Mini-WSB Inline; for Smart Printer; 1700 pieces on roll; stretchable 5 - 5.2 mm; plain; snap-on type; violet	 : 2009-145 Mini-WSB Inline; for Smart Printer; 1700 pieces on roll; stretchable 5 - 5.2 mm; plain; snap-on type; white	 : 2009-145/000-002 Mini-WSB Inline; for Smart Printer; 1700 pieces on roll; stretchable 5 - 5.2 mm; plain; snap-on type; yellow
 : 248-501/000-006 Mini-WSB marking card; as card; not stretchable; plain; snap-on type; blue	 : 248-501/000-007 Mini-WSB marking card; as card; not stretchable; plain; snap-on type; gray	 : 248-501/000-023 Mini-WSB marking card; as card; not stretchable; plain; snap-on type; green	 : 248-501/000-017 Mini-WSB marking card; as card; not stretchable; plain; snap-on type; light green
 : 248-501/000-012 Mini-WSB marking card; as card; not stretchable; plain; snap-on type; orange	 : 248-501/000-005 Mini-WSB marking card; as card; not stretchable; plain; snap-on type; red	 : 248-501/000-024 Mini-WSB marking card; as card; not stretchable; plain; snap-on type; violet	 : 248-501 Mini-WSB marking card; as card; not stretchable; plain; snap-on type; white
 : 248-501/000-002 Mini-WSB marking card; as card; not stretchable; plain; snap-on type; yellow	 : 793-5501/000-006 WMB marking card; as card; for terminal block width 5 - 17.5 mm; stretchable 5 - 5.2 mm; plain; snap-on type; blue	 : 793-5501/000-007 WMB marking card; as card; for terminal block width 5 - 17.5 mm; stretchable 5 - 5.2 mm; plain; snap-on type; gray	 : 793-5501/000-023 WMB marking card; as card; for terminal block width 5 - 17.5 mm; stretchable 5 - 5.2 mm; plain; snap-on type; green
 : 793-5501/000-017 WMB marking card; as card; for terminal block width 5 - 17.5 mm; stretchable 5 - 5.2 mm; plain; snap-on type; light green	 : 793-5501/000-012 WMB marking card; as card; for terminal block width 5 - 17.5 mm; stretchable 5 - 5.2 mm; plain; snap-on type; orange	 : 793-5501/000-005 WMB marking card; as card; for terminal block width 5 - 17.5 mm; stretchable 5 - 5.2 mm; plain; snap-on type; red	 : 793-5501/000-024 WMB marking card; as card; for terminal block width 5 - 17.5 mm; stretchable 5 - 5.2 mm; plain; snap-on type; violet

## 1.1.1.3 Marker

**: 793-5501**

WMB marking card; as card; for terminal block width 5 - 17.5 mm; stretchable 5 - 5.2 mm; plain; snap-on type; white

**: 793-5501/000-002**

WMB marking card; as card; for terminal block width 5 - 17.5 mm; stretchable 5 - 5.2 mm; plain; snap-on type; yellow

**: 793-501/000-006**

WMB marking card; as card; not stretchable; plain; snap-on type; blue

**: 793-501/000-007**

WMB marking card; as card; not stretchable; plain; snap-on type; gray

**: 793-501/000-023**

WMB marking card; as card; not stretchable; plain; snap-on type; green

**: 793-501/000-017**

WMB marking card; as card; not stretchable; plain; snap-on type; light green

**: 793-501/000-012**

WMB marking card; as card; not stretchable; plain; snap-on type; orange

**: 793-501/000-005**

WMB marking card; as card; not stretchable; plain; snap-on type; red

**: 793-501/000-024**

WMB marking card; as card; not stretchable; plain; snap-on type; violet

**: 793-501**

WMB marking card; as card; not stretchable; plain; snap-on type; white

**: 793-501/000-002**

WMB marking card; as card; not stretchable; plain; snap-on type; yellow

**: 2009-115/000-006**

WMB-Inline; for Smart Printer; 1500 pieces on roll; stretchable 5 - 5.2 mm; plain; snap-on type; blue

**: 2009-115/000-007**

WMB-Inline; for Smart Printer; 1500 pieces on roll; stretchable 5 - 5.2 mm; plain; snap-on type; gray

**: 2009-115/000-023**

WMB-Inline; for Smart Printer; 1500 pieces on roll; stretchable 5 - 5.2 mm; plain; snap-on type; green

**: 2009-115/000-017**

WMB-Inline; for Smart Printer; 1500 pieces on roll; stretchable 5 - 5.2 mm; plain; snap-on type; light green

**: 2009-115/000-012**

WMB-Inline; for Smart Printer; 1500 pieces on roll; stretchable 5 - 5.2 mm; plain; snap-on type; orange

## Installation notes

## Installation

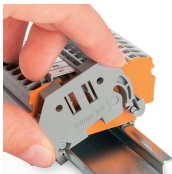

Snap-on mounting

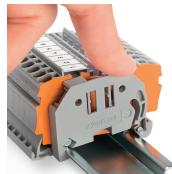

That's it!

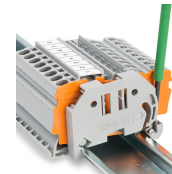
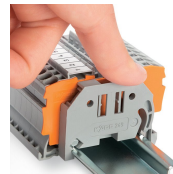

Removing an end stop from the DIN-rail.