

Data Sheet | Item Number: 222-412

Splicing connector with levers; for all conductor types; max. 4 mm²; 2-conductor;
gray housing; Surrounding air temperature: max 40°C; 2,50 mm²; gray

<https://www.wago.com/222-412>



Color: ■ gray

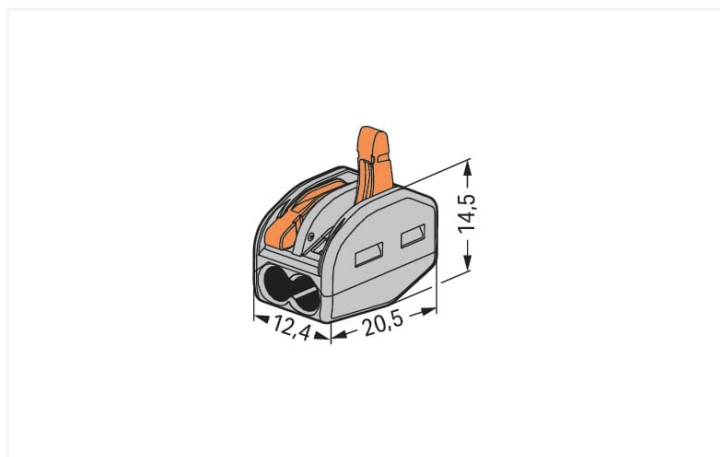

Dimensions in mm

Notes

Safety management note

NOTICE: Observe installation and safety instructions!

- **Only to be used by electricians!**
- Do not work under voltage/load!
- Use only for proper use!
- Observe national regulations/standards/guidelines!
- Observe technical specifications for the products!
- Observe the number of permissible potentials!
- Do not use damaged/dirty components!
- Observe conductor types, cross-sections and strip lengths!
- Insert conductor until it hits the product's backstop!
- Use original accessories!

To be sold only with installation instructions!

Safety information

in grounded power lines

Electrical data

Ratings per	EN 60664		
Overvoltage category	III	III	II
Pollution degree	3	2	2
Nominal voltage	-	-	400 V
Rated surge voltage	-	-	4 kV
Rated current	-	-	32 A

Connection data

Connection points	2
Total number of potentials	1

Connection 1

Connection technology	CAGE CLAMP®
Actuation type	Lever
Connectable conductor materials	Copper Aluminum
Solid conductor	0.08 ... 2.5 mm ² / 28 ... 12 AWG
Stranded conductor	0.08 ... 2.5 mm ² / 28 ... 12 AWG
Fine-stranded conductor	0.08 ... 4 mm ² / 28 ... 12 AWG
Strip length	9 ... 10 mm / 0.35 ... 0.39 inches
Wiring direction	Side-entry wiring

Physical data

Width	12.4 mm / 0.488 inches
Height	14.5 mm / 0.571 inches
Depth	20.5 mm / 0.807 inches

Material data

Note (material data)

[Information on material specifications can be found here](#)

Color	gray
Flammability class per UL94	V0
Fire load	0.067 MJ
Actuator color	orange
Weight	3.1 g

Environmental requirements

Ambient temperature (operation)	+40 °C
Continuous operating temperature	85 °C

Commercial data

eCl@ss 10.0	27-14-11-04
eCl@ss 9.0	27-14-11-04
ETIM 8.0	EC000446
ETIM 7.0	EC000446
PU (SPU)	500 (50) pcs
Packaging type	Box
Country of origin	DE
GTIN	4050821346470
Customs tariff number	85369010000

Environmental Product Compliance

RoHS Compliance Status	Compliant, No Exemption
------------------------	-------------------------

Approvals / Certificates

General approvals



Approval	Standard	Certificate Name
ENEC 15 UL International Demko A/S	EN 60998	ENEC-01360
UL_Listed_64KA UL International Germany GmbH	UL 467	E201573
UL UL International Germany GmbH	UL 486C	E69654

Declarations of conformity and manufacturer's declarations

Approval	Standard	Certificate Name
EU-Declaration of Conformity WAGO GmbH & Co. KG	-	-
UK-Declaration of Conformity WAGO GmbH & Co. KG	-	-

Approvals for marine applications



Approval	Standard	Certificate Name
ABS American Bureau of Shipping	-	18-HG1755093-PDA
DNV GL Det Norske Veritas, Germanischer Lloyd	EN 60998	TAE000015T
LR Lloyds Register	EN 60998	LR22207029TA

Downloads

Environmental Product Compliance

Compliance Search

Environmental Product Compliance 222-412



Documentation

Bid Text

222-412	19.02.2019	xml 3.38 KB	
222-412	23.01.2019	docx 15.35 KB	

CAD/CAE-Data

CAD data

2D/3D Models 222-412



CAE data

EPLAN Data Portal 222-412



WSCAD Universe 222-412



ZUKEN Portal 222-412



1 Compatible Products

1.1 Optional Accessories

1.1.1 Mounting adapter

1.1.1.1 Mounting accessories



Item No.: 222-500

Mounting carrier; 222 Series; for DIN-35 rail mounting/screw mounting; orange

Installation Notes

Conductor termination

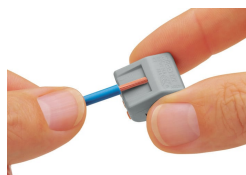

Strip conductor to 9 ... 10 mm (0.35 ... 0.39 inch).

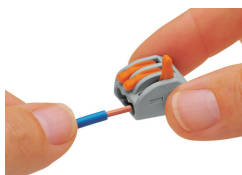

Termination: Lift the lever to open the clamping unit and insert a stripped conductor.

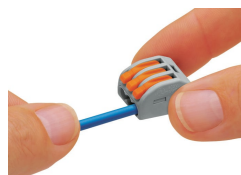

Then, lower the lever to close the clamp.

Testing



Testing via Profi-LED+ voltage tester (206-806).

Application

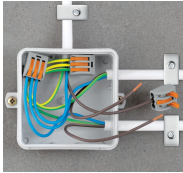

Wiring fine-stranded conductors in junction boxes.



Custom low-voltage lighting system

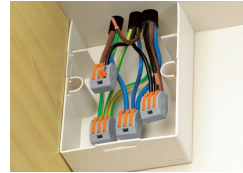

Connecting pre-wired and pre-fabricated components (e.g., in mobile homes).

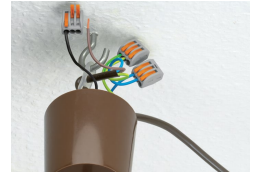

Lighting fixture connection with fine-stranded wires and power feed

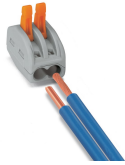

Compact, lever-operated splicing connectors:

They connect up to five stripped, fine-stranded conductors from 0.08 to 4 mm² (28 ... 12 AWG), as well as solid or stranded conductors from up to 2.5 mm² (12 AWG) – without tools!

How they work:

Pull up one of the orange operating levers to open the clamping unit so that the lever engages and keeps the clamp in its opened position. Then insert the conductor and push the lever back down, flush with the connector housing.

Safety:

The lever's specially designed rest position reliably prevents accidental unclamping of a connected conductor. Application safety, for any type of conductor (solid, stranded, fine-stranded), is confirmed by approvals like ENEC or UL.

ENEC is the European mark for electrical products that demonstrates compliance with European safety standards. The ENEC mark is subjected to the same EN standards as the VDE mark.

While the VDE mark is only permitted in Germany, the ENEC mark is accepted in more than 20 European countries.