

Data Sheet | Item Number: 2002-1201

2-conductor through terminal block; 2.5 mm²; suitable for Ex e II applications; side and center marking; for DIN-rail 35 x 15 and 35 x 7.5; Push-in CAGE CLAMP®; 2,50 mm²; gray

<https://www.wago.com/2002-1201>

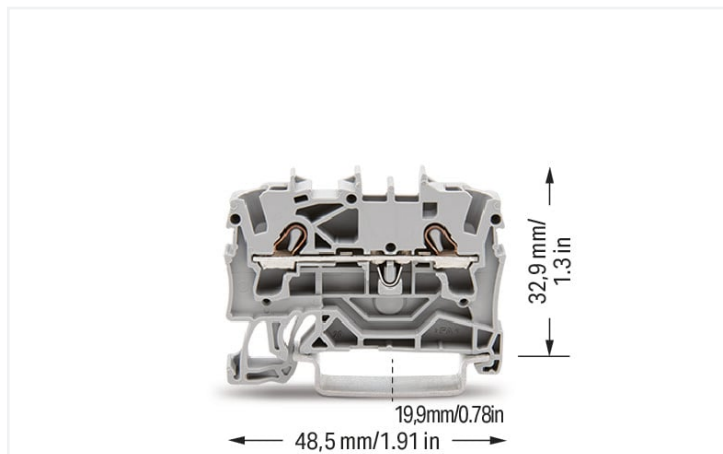

Color: ■ gray

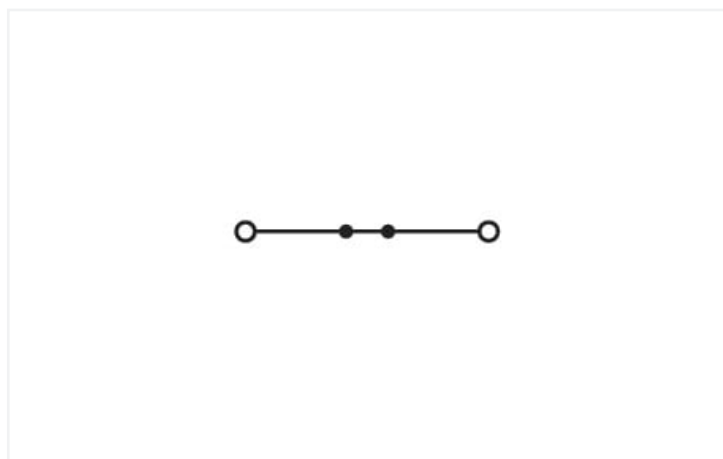

Similar to illustration

Electrical data

| Ratings per | IEC/EN 60947-7-1 | | |
|---|------------------|-----|----|
| Overvoltage category | III | III | II |
| Pollution degree | 3 | 2 | 2 |
| Nominal voltage | 800 V | - | - |
| Rated surge voltage | 8 kV | - | - |
| Rated current | 24 A | - | - |
| Current at conductor cross-section (max.) mm ² | 32 A | - | - |

| Approvals per | UL 1059 | | |
|---------------|---------|-------|---|
| Use group | B | C | D |
| Rated voltage | 600 V | 600 V | - |
| Rated current | 20 A | 20 A | - |

| Approvals per | CSA 22.2 No 158 | | |
|---------------|-----------------|-------|---|
| Use group | B | C | D |
| Rated voltage | 600 V | 600 V | - |
| Rated current | 20 A | 20 A | - |

| Ex information | |
|-------------------------------------|---|
| Reference hazardous areas | See application instructions in section "Knowledge and Downloads – Documentation – Additional Information: Technical Section; Technical Explanations" |
| Ratings per | ATEX: PTB 03 ATEX 1162 U / IECEx: PTB 03.0004U (Ex eb IIC Gb) |
| Rated voltage EN (Ex e II) | 550 V |
| Rated current (Ex e II) | 22 A |
| Rated current (Ex e II) with jumper | 20 A |

Power Loss

| | |
|--|------------------|
| Power loss, per pole (potential) | 0.7661 W |
| Rated current I_N for specified power loss | 24 A |
| Resistance value for specified, current-dependent power loss | 0.00133 Ω |

Connection data

| | |
|----------------------------|---|
| Connection points | 2 |
| Total number of potentials | 1 |
| Number of levels | 1 |
| Number of jumper slots | 2 |

Connection 1

| | |
|--|---|
| Connection technology | Push-in CAGE CLAMP® |
| Actuation type | Operating tool |
| Connectable conductor materials | Copper |
| Nominal cross-section | 2.5 mm ² |
| Solid conductor | 0.25 ... 4 mm ² / 22 ... 12 AWG |
| Solid conductor; push-in termination | 1 ... 4 mm ² / 18 ... 12 AWG |
| Fine-stranded conductor | 0.25 ... 4 mm ² / 22 ... 12 AWG |
| Fine-stranded conductor; with insulated ferrule | 0.25 ... 2.5 mm ² / 22 ... 14 AWG |
| Fine-stranded conductor; with ferrule; push-in termination | 1 ... 2.5 mm ² / 18 ... 14 AWG |
| Note (conductor cross-section) | Depending on the conductor characteristic, a conductor with a smaller cross-section can also be inserted via push-in termination. |
| Strip length | 10 ... 12 mm / 0.39 ... 0.47 inches |
| Wiring direction | Front-entry wiring |

Physical data

| | |
|-----------------------------------|------------------------|
| Width | 5.2 mm / 0.205 inches |
| Height | 48.5 mm / 1.909 inches |
| Depth from upper-edge of DIN-rail | 32.9 mm / 1.295 inches |

Mechanical data

| | |
|---------------|---------------------|
| Mounting type | DIN-35 rail |
| Marking level | Center/side marking |

Material data

| | |
|-----------------------------|--|
| Note (material data) | Information on material specifications can be found here |
| Color | gray |
| Material group | I |
| Insulation material | Polyamide (PA66) |
| Flammability class per UL94 | V0 |
| Fire load | 0.128 MJ |
| Weight | 5.1 g |

Environmental requirements

| | |
|----------------------------------|-----------------|
| Processing temperature | -35 ... +85 °C |
| Continuous operating temperature | -60 ... +105 °C |

Commercial data

| | |
|----------------|---------------|
| Product Group | 22 (TOPJOB S) |
| eCl@ss 10.0 | 27-14-11-20 |
| eCl@ss 9.0 | 27-14-11-20 |
| ETIM 8.0 | EC000897 |
| ETIM 7.0 | EC000897 |
| PU (SPU) | 100 pcs |
| Packaging type | Box |
| GTIN | 4017332999168 |

Environmental Product Compliance

| | |
|------------------------|-------------------------|
| RoHS Compliance Status | Compliant, No Exemption |
|------------------------|-------------------------|

Approvals / Certificates

General approvals



| Approval | Standard | Certificate Name |
|---------------------------------------|---------------|------------------|
| CCA DEKRA Certification B.V. | EN 60947 | NTR NL 7941 |
| CSA DEKRA Certification B.V. | C22.2 No. 158 | 1536069 |
| KEMA/KEUR DEKRA Certification B.V. | EN 60947 | 71-124163 |
| UL Underwriters Laboratories Inc. | UL 1059 | E45172 |

Declarations of conformity and manufacturer's declarations



| Approval | Standard | Certificate Name |
|--|----------|------------------|
| ATEX-Attestation of Conformity WAGO GmbH & Co. KG | - | - |
| EU-Declaration of Conformity WAGO GmbH & Co. KG | - | - |
| Railway WAGO GmbH & Co. KG | - | Railway Ready |
| UK-Declaration of Conformity WAGO GmbH & Co. KG | - | - |

Approvals for marine applications



| Approval | Standard | Certificate Name |
|--|----------|------------------|
| ABS American Bureau of Shipping | EN 60947 | 20-HG1941090-PDA |
| BV Bureau Veritas S.A. | EN 60947 | 38586/B0 BV |
| DNV GL Det Norske Veritas, Germanischer Lloyd | - | TAE00001V2 |

Approvals for hazardous areas



| Approval | Standard | Certificate Name |
|--|----------------|---|
| AEx Underwriters Laboratories Inc. | UL 60079 | E185892 (AEx eb IIC resp. Ex eb IIC) |
| ATEX Physikalisch Technische Bundesanstalt | EN 60079 | PTB 03 ATEX 1162 U (II2G Ex eb IIC Gb, IM2 Ex eb IMb) |
| CCC CNEX | GB/T 3836.3 | 2020312313000238 (Ex eb IIC Gb, Ex eb I Mb) |
| EAC Brjansker Zertifizierungsstelle | TP TC 012/2011 | RU C-DE.AM02. B.00127/19 (Ex e IIC Gb U) |
| IECEX Physikalisch Technische Bundesanstalt | IEC 60079 | IECEX PTB 03.0004U (Ex eb IIC Gb or Ex eb I Mb) |
| INMETRO TUV Rheinland do Brasil Ltda. | IEC 60079 | TUV 12.1307 U |

Approvals for hazardous areas

| | | |
|---------------------------------|-----------------------------------|----------------|
| KTL Korea Testing Laboratory | EN IEC 60079-0, EN IEC 60079-7 | 19-KA4B0-0921U |
|---------------------------------|-----------------------------------|----------------|

Downloads

Environmental Product Compliance

| | |
|--|-------------------|
| Compliance Search | |
| Environmental Product Compliance 2002-1201 | ↓ |

Documentation

| | | | |
|-----------------|------------|------------------|-------------------|
| Bid Text | | | |
| 2002-1201 | 29.04.2019 | xml 4.15 KB | ↓ |
| 2002-1201 | 23.04.2019 | docx 14.68 KB | ↓ |

CAD/CAE-Data

| | |
|---------------------------|-------------------|
| CAD data | |
| 2D/3D Models 2002-1201 | ↓ |

| | |
|--------------------------------|-------------------|
| CAE data | |
| EPLAN Data Portal 2002-1201 | ↓ |
| WSCAD Universe 2002-1201 | ↓ |
| ZUKEN Portal 2002-1201 | ↓ |

1 Compatible Products

1.1 Required Accessories

1.1.1 End plate

1.1.1.1 End plate



Item No.: 2002-1291
End and intermediate plate; 0.8 mm thick; gray



Item No.: 2002-1292
End and intermediate plate; 0.8 mm thick; orange



Item No.: 209-191
Separator for Ex e/Ex i applications; 3 mm thick; 120 mm wide; orange



Item No.: 209-190
Separator for Ex e/Ex i applications; 3 mm thick; 90 mm wide; orange



Item No.: 2002-1293
Separator plate; 2 mm thick; oversized; gray



Item No.: 2002-1294
Separator plate; 2 mm thick; oversized; orange

1.2 Optional Accessories

1.2.1 DIN-rail

1.2.1.1 Mounting accessories



Item No.: 210-196

Aluminum carrier rail; 35 x 8.2 mm; 1.6 mm thick; 2 m long; unslotted; similar to EN 60715; silver-colored



Item No.: 210-198

Copper carrier rail; 35 x 15 mm; 2.3 mm thick; 2 m long; unslotted; according to EN 60715; copper-colored



Item No.: 210-508

Steel carrier rail; 35 x 15 mm; 1.5 mm thick; 2 m long; slotted; galvanized; similar to EN 60715; silver-colored



Item No.: 210-197

Steel carrier rail; 35 x 15 mm; 1.5 mm thick; 2 m long; slotted; similar to EN 60715; silver-colored



Item No.: 210-506

Steel carrier rail; 35 x 15 mm; 1.5 mm thick; 2 m long; unslotted; galvanized; similar to EN 60715; silver-colored



Item No.: 210-114

Steel carrier rail; 35 x 15 mm; 1.5 mm thick; 2 m long; unslotted; similar to EN 60715; silver-colored



Item No.: 210-118

Steel carrier rail; 35 x 15 mm; 2.3 mm thick; 2 m long; unslotted; according to EN 60715; silver-colored



Item No.: 210-115

Steel carrier rail; 35 x 7.5 mm; 1 mm thick; 2 m long; slotted; according to EN 60715; "Hole width 18 mm; silver-colored



Item No.: 210-112

Steel carrier rail; 35 x 7.5 mm; 1 mm thick; 2 m long; slotted; according to EN 60715; "Hole width 25 mm; silver-colored



Item No.: 210-504

Steel carrier rail; 35 x 7.5 mm; 1 mm thick; 2 m long; slotted; galvanized; according to EN 60715; silver-colored



Item No.: 210-113

Steel carrier rail; 35 x 7.5 mm; 1 mm thick; 2 m long; unslotted; according to EN 60715; silver-colored



Item No.: 210-505

Steel carrier rail; 35 x 7.5 mm; 1 mm thick; 2 m long; unslotted; galvanized; according to EN 60715; silver-colored

1.2.2 Ferrule

1.2.2.1 Ferrule



Item No.: 216-241

Ferrule; Sleeve for 0.5 mm² / 20 AWG; insulated; electro-tin plated; electrolytic copper; gastight crimped; acc. to DIN 46228, Part 4/09.90; white



Item No.: 216-242

Ferrule; Sleeve for 0.75 mm² / 18 AWG; insulated; electro-tin plated; electrolytic copper; gastight crimped; acc. to DIN 46228, Part 4/09.90; gray



Item No.: 216-262

Ferrule; Sleeve for 0.75 mm² / 18 AWG; insulated; electro-tin plated; electrolytic copper; gastight crimped; acc. to DIN 46228, Part 4/09.90; gray



Item No.: 216-243

Ferrule; Sleeve for 1 mm² / AWG 18; insulated; electro-tin plated; electrolytic copper; gastight crimped; acc. to DIN 46228, Part 4/09.90; red



Item No.: 216-263

Ferrule; Sleeve for 1 mm² / AWG 18; insulated; electro-tin plated; electrolytic copper; gastight crimped; acc. to DIN 46228, Part 4/09.90; red



Item No.: 216-244

Ferrule; Sleeve for 1.5 mm² / AWG 16; insulated; electro-tin plated; electrolytic copper; gastight crimped; acc. to DIN 46228, Part 4/09.90; black



Item No.: 216-264

Ferrule; Sleeve for 1.5 mm² / AWG 16; insulated; electro-tin plated; electrolytic copper; gastight crimped; acc. to DIN 46228, Part 4/09.90; black



Item No.: 216-246

Ferrule; Sleeve for 2.5 mm² / AWG 14; insulated; electro-tin plated; electrolytic copper; gastight crimped; acc. to DIN 46228, Part 4/09.90; blue



Item No.: 216-266

Ferrule; Sleeve for 2.5 mm² / AWG 14; insulated; electro-tin plated; electrolytic copper; gastight crimped; acc. to DIN 46228, Part 4/09.90; blue

1.2.3 Installation

1.2.3.1 Cover



Item No.: 709-156

Cover; Type 3; suitable for cover carrier, type 3; 1 m long; transparent

1.2.3.2 Cover carrier



Item No.: 709-169
 Cover carrier; Type 3; incl. fixing/retaining screws and knurled nut; suitable for 279 to 282 and 880 Series rail-mounted terminal blocks; suitable for 264 Series miniature rail-mounted terminal blocks; suitable for 270 Series sensor and actuator terminal blocks; gray

1.2.4 Insulation stop

1.2.4.1 Insulation stop



Item No.: 2002-171
 Insulation stop; 0.25 - 0.5 mm²; 5 pieces/strip; light gray



Item No.: 2002-172
 Insulation stop; 0.75 - 1 mm²; 5 pieces/strip; dark gray

1.2.5 Jumper

1.2.5.1 Jumper



Item No.: 2002-400
 Continuous jumper; 2-way; insulated; light gray



Item No.: 2002-423/000-006
 Continuous jumper; from 1 to 3; insulated; blue



Item No.: 2002-423
 Continuous jumper; from 1 to 3; insulated; light gray



Item No.: 2002-423/000-005
 Continuous jumper; from 1 to 3; insulated; red



Item No.: 2002-424/000-006
 Continuous jumper; from 1 to 4; insulated; blue



Item No.: 2002-424
 Continuous jumper; from 1 to 4; insulated; light gray



Item No.: 2002-424/000-005
 Continuous jumper; from 1 to 4; insulated; red



Item No.: 2002-406/020-000
 Delta jumper; insulated; light gray



Item No.: 2002-410/000-006
 Jumper; 10-way; insulated; blue



Item No.: 2002-410
 Jumper; 10-way; insulated; light gray



Item No.: 2002-410/000-005
 Jumper; 10-way; insulated; red



Item No.: 2002-402/000-006
 Jumper; 2-way; insulated; blue



Item No.: 2002-402
 Jumper; 2-way; insulated; light gray



Item No.: 2002-402/000-005
 Jumper; 2-way; insulated; red



Item No.: 2002-403/000-006
 Jumper; 3-way; insulated; blue



Item No.: 2002-403
 Jumper; 3-way; insulated; light gray



Item No.: 2002-403/000-005
 Jumper; 3-way; insulated; red



Item No.: 2002-404/000-006
 Jumper; 4-way; insulated; blue



Item No.: 2002-404
 Jumper; 4-way; insulated; light gray



Item No.: 2002-404/000-005
 Jumper; 4-way; insulated; red



Item No.: 2002-405/000-006
 Jumper; 5-way; insulated; blue



Item No.: 2002-405
 Jumper; 5-way; insulated; light gray



Item No.: 2002-405/000-005
 Jumper; 5-way; insulated; red



Item No.: 2002-406/000-006
 Jumper; 6-way; insulated; blue



Item No.: 2002-406
 Jumper; 6-way; insulated; light gray



Item No.: 2002-406/000-005
 Jumper; 6-way; insulated; red



Item No.: 2002-407/000-006
 Jumper; 7-way; insulated; blue



Item No.: 2002-407
 Jumper; 7-way; insulated; light gray



Item No.: 2002-407/000-005
 Jumper; 7-way; insulated; red



Item No.: 2002-408/000-006
 Jumper; 8-way; insulated; blue



Item No.: 2002-408
 Jumper; 8-way; insulated; light gray



Item No.: 2002-408/000-005
 Jumper; 8-way; insulated; red



Item No.: 2002-409/000-006
 Jumper; 9-way; insulated; blue



Item No.: 2002-409
 Jumper; 9-way; insulated; light gray



Item No.: 2002-409/000-005
 Jumper; 9-way; insulated; red





Item No.: 2002-440
 Jumper; from 1 to 10; insulated; light gray

1.2.5.1 Jumper













| | | | |
|---|---|--|---|
|  Item No.: 2002-433 Jumper; from 1 to 3; insulated; light gray |  Item No.: 2002-434 Jumper; from 1 to 4; insulated; light gray |  Item No.: 2002-435 Jumper; from 1 to 5; insulated; light gray |  Item No.: 2002-436 Jumper; from 1 to 6; insulated; light gray |
|  Item No.: 2002-437 Jumper; from 1 to 7; insulated; light gray |  Item No.: 2002-438 Jumper; from 1 to 8; insulated; light gray |  Item No.: 2002-439 Jumper; from 1 to 9; insulated; light gray |  Item No.: 2002-480 Staggered jumper; 10-way; insulated; light gray |
|  Item No.: 2002-481 Staggered jumper; 11-way; insulated; light gray |  Item No.: 2002-482 Staggered jumper; 12-way; insulated; light gray |  Item No.: 2002-473/011-000 Staggered jumper; 2-way; from 1 to 3; insulated; light gray |  Item No.: 2002-472 Staggered jumper; 2-way; insulated; light gray |
|  Item No.: 2002-473 Staggered jumper; 3-way; insulated; light gray |  Item No.: 2002-475/011-000 Staggered jumper; 3-way; insulated; light gray |  Item No.: 2002-474 Staggered jumper; 4-way; insulated; light gray |  Item No.: 2002-475 Staggered jumper; 5-way; insulated; light gray |
|  Item No.: 2002-476 Staggered jumper; 6-way; insulated; light gray |  Item No.: 2002-477 Staggered jumper; 7-way; insulated; light gray |  Item No.: 2002-478 Staggered jumper; 8-way; insulated; light gray |  Item No.: 2002-479 Staggered jumper; 9-way; insulated; light gray |
|  Item No.: 2002-477/011-000 Staggered jumper; insulated; light gray |  Item No.: 2002-479/011-000 Staggered jumper; insulated; light gray |  Item No.: 2002-481/011-000 Staggered jumper; insulated; light gray |  Item No.: 2002-405/011-000 Star point jumper; 3-way; insulated; light gray |
|  Item No.: 2006-499 Step-down jumper; from 2006/2004 to 2004/2002/2001 series; from 2206/2204 to 2204/2202/2201 series; insulated; light gray |  Item No.: 2016-499 Step-down jumper; from 2016/2010 to 2010/2006/2004/2002 series; from 2216/2210 to 2210/2206/2204/2202 series; insulated; light gray |  Item No.: 210-103 Wire commoning chain; insulated; black |  Item No.: 210-123 Wire commoning chain; insulated; blue |

1.2.6 Marking

1.2.6.1 Group marker carrier

| | | |
|--|--|--|
|  Item No.: 2009-191 Group marker carrier; gray |  Item No.: 2009-192 Group marker carrier; gray |  Item No.: 2009-193 Group marker carrier; gray |
|--|--|--|

1.2.6.2 Marker

| | | | |
|--|--|--|--|
|  Item No.: 2009-145/000-006 Mini-WSB Inline; for Smart Printer; 1700 pieces on roll; stretchable 5 - 5.2 mm; plain; snap-on type; blue |  Item No.: 2009-145/000-007 Mini-WSB Inline; for Smart Printer; 1700 pieces on roll; stretchable 5 - 5.2 mm; plain; snap-on type; gray |  Item No.: 2009-145/000-023 Mini-WSB Inline; for Smart Printer; 1700 pieces on roll; stretchable 5 - 5.2 mm; plain; snap-on type; green |  Item No.: 2009-145/000-012 Mini-WSB Inline; for Smart Printer; 1700 pieces on roll; stretchable 5 - 5.2 mm; plain; snap-on type; orange |
|  Item No.: 2009-145/000-005 Mini-WSB Inline; for Smart Printer; 1700 pieces on roll; stretchable 5 - 5.2 mm; plain; snap-on type; red |  Item No.: 2009-145/000-024 Mini-WSB Inline; for Smart Printer; 1700 pieces on roll; stretchable 5 - 5.2 mm; plain; snap-on type; violet |  Item No.: 2009-145 Mini-WSB Inline; for Smart Printer; 1700 pieces on roll; stretchable 5 - 5.2 mm; plain; snap-on type; white |  Item No.: 2009-145/000-002 Mini-WSB Inline; for Smart Printer; 1700 pieces on roll; stretchable 5 - 5.2 mm; plain; snap-on type; yellow |
|  Item No.: 248-501/000-006 Mini-WSB marking card; as card; not stretchable; plain; snap-on type; blue |  Item No.: 248-501/000-007 Mini-WSB marking card; as card; not stretchable; plain; snap-on type; gray |  Item No.: 248-501/000-023 Mini-WSB marking card; as card; not stretchable; plain; snap-on type; green |  Item No.: 248-501/000-017 Mini-WSB marking card; as card; not stretchable; plain; snap-on type; light green |

1.2.6.2 Marker



Item No.: 248-501/000-012
Mini-WSB marking card; as card; not stretchable; plain; snap-on type; orange

Item No.: 248-501/000-005
Mini-WSB marking card; as card; not stretchable; plain; snap-on type; red

Item No.: 248-501/000-024
Mini-WSB marking card; as card; not stretchable; plain; snap-on type; violet

Item No.: 248-501
Mini-WSB marking card; as card; not stretchable; plain; snap-on type; white



Item No.: 248-501/000-002
Mini-WSB marking card; as card; not stretchable; plain; snap-on type; yellow

Item No.: 793-5501/000-006
WMB marking card; as card; for terminal block width 5 - 17.5 mm; stretchable 5 - 5.2 mm; plain; snap-on type; blue

Item No.: 793-5501/000-014
WMB marking card; as card; for terminal block width 5 - 17.5 mm; stretchable 5 - 5.2 mm; plain; snap-on type; brown

Item No.: 793-5501/000-007
WMB marking card; as card; for terminal block width 5 - 17.5 mm; stretchable 5 - 5.2 mm; plain; snap-on type; gray



Item No.: 793-5501/000-023
WMB marking card; as card; for terminal block width 5 - 17.5 mm; stretchable 5 - 5.2 mm; plain; snap-on type; green

Item No.: 793-5501/000-017
WMB marking card; as card; for terminal block width 5 - 17.5 mm; stretchable 5 - 5.2 mm; plain; snap-on type; light green

Item No.: 793-5501/000-012
WMB marking card; as card; for terminal block width 5 - 17.5 mm; stretchable 5 - 5.2 mm; plain; snap-on type; orange

Item No.: 793-5501/000-005
WMB marking card; as card; for terminal block width 5 - 17.5 mm; stretchable 5 - 5.2 mm; plain; snap-on type; red



Item No.: 793-5501/000-024
WMB marking card; as card; for terminal block width 5 - 17.5 mm; stretchable 5 - 5.2 mm; plain; snap-on type; violet

Item No.: 793-5501
WMB marking card; as card; for terminal block width 5 - 17.5 mm; stretchable 5 - 5.2 mm; plain; snap-on type; white

Item No.: 793-5501/000-002
WMB marking card; as card; for terminal block width 5 - 17.5 mm; stretchable 5 - 5.2 mm; plain; snap-on type; yellow

Item No.: 2009-115/000-006
WMB-Inline; for Smart Printer; 1500 pieces on roll; stretchable 5 - 5.2 mm; plain; snap-on type; blue



Item No.: 2009-115/000-007
WMB-Inline; for Smart Printer; 1500 pieces on roll; stretchable 5 - 5.2 mm; plain; snap-on type; gray

Item No.: 2009-115/000-023
WMB-Inline; for Smart Printer; 1500 pieces on roll; stretchable 5 - 5.2 mm; plain; snap-on type; green

Item No.: 2009-115/000-017
WMB-Inline; for Smart Printer; 1500 pieces on roll; stretchable 5 - 5.2 mm; plain; snap-on type; light green

Item No.: 2009-115/000-012
WMB-Inline; for Smart Printer; 1500 pieces on roll; stretchable 5 - 5.2 mm; plain; snap-on type; orange



Item No.: 2009-115/000-005
WMB-Inline; for Smart Printer; 1500 pieces on roll; stretchable 5 - 5.2 mm; plain; snap-on type; red

Item No.: 2009-115/000-024
WMB-Inline; for Smart Printer; 1500 pieces on roll; stretchable 5 - 5.2 mm; plain; snap-on type; violet

Item No.: 2009-115
WMB-Inline; for Smart Printer; 1500 pieces on roll; stretchable 5 - 5.2 mm; plain; snap-on type; white

Item No.: 2009-115/000-002
WMB-Inline; for Smart Printer; 1500 pieces on roll; stretchable 5 - 5.2 mm; plain; snap-on type; yellow

1.2.6.3 Marker carrier



Item No.: 2002-161
Adaptor; gray

Item No.: 2009-198
Adaptor; gray

1.2.6.4 Marking strip



Item No.: 2009-110
Marking strips; for Smart Printer; on reel; not stretchable; plain; snap-on type; white

1.2.7 Plug

1.2.7.1 Component module with diode



Item No.: 2002-880/1000-411
Component plug; 2-pole; with diode 1N4007; 10.4 mm wide; Operating temperature 85°C max.; gray

1.2.7.2 Component module with LED



Item No.: 2002-880/1000-541

Component plug; 2-pole; LED (red); 10.4 mm wide; Operating temperature 85°C max.; gray

Item No.: 2002-880/1000-836

Component plug; 2-pole; LED (red); 10.4 mm wide; Operating temperature 85°C max.; gray

Item No.: 2002-880/1000-542

Component plug; 2-pole; LED (red); 10.4 mm wide; Operating temperature 85°C max.; multicoloured

1.2.7.3 Empty component plug housing



Item No.: 2002-880

Empty component plug housing; 10.4 mm wide; 2-pole; Type 4; gray

1.2.8 Protective warning marker

1.2.8.1 Cover



Item No.: 2002-115

Protective warning marker; for 5 terminal blocks; with high-voltage symbol, black; yellow

1.2.9 Push-in type wire jumper

1.2.9.1 Jumper



Item No.: 2009-414

Push-in type wire jumper; 1.5 mm²; insulated; 110 mm long; black



Item No.: 2009-414/000-005

Push-in type wire jumper; 1.5 mm²; insulated; 110 mm long; black



Item No.: 2009-416

Push-in type wire jumper; 1.5 mm²; insulated; 250 mm long; black



Item No.: 2009-414/000-006

Push-in type wire jumper; insulated; 110 mm long; black



Item No.: 2009-412

Push-in type wire jumper; insulated; 60 mm long; black

1.2.10 Screwless end stop

1.2.10.1 Mounting accessories



Item No.: 249-117

Screwless end stop; 10 mm wide; for DIN-rail 35 x 15 and 35 x 7.5; gray



Item No.: 249-116

Screwless end stop; 6 mm wide; for DIN-rail 35 x 15 and 35 x 7.5; gray

1.2.11 Test and measurement

1.2.11.1 Testing accessories



Item No.: 2002-560
Modular TOPJOB®S connector; modular; for jumper contact slot; 10-pole; 2,50 mm²; gray



Item No.: 2002-511
Modular TOPJOB®S connector; modular; for jumper contact slot; 1-pole; 2,50 mm²; gray



Item No.: 2002-552
Modular TOPJOB®S connector; modular; for jumper contact slot; 2-pole; 2,50 mm²; gray



Item No.: 2002-553
Modular TOPJOB®S connector; modular; for jumper contact slot; 3-pole; 2,50 mm²; gray



Item No.: 2002-554
Modular TOPJOB®S connector; modular; for jumper contact slot; 4-pole; 2,50 mm²; gray



Item No.: 2002-555
Modular TOPJOB®S connector; modular; for jumper contact slot; 5-pole; 2,50 mm²; gray



Item No.: 2002-556
Modular TOPJOB®S connector; modular; for jumper contact slot; 6-pole; 2,50 mm²; gray



Item No.: 2002-557
Modular TOPJOB®S connector; modular; for jumper contact slot; 7-pole; 2,50 mm²; gray



Item No.: 2002-558
Modular TOPJOB®S connector; modular; for jumper contact slot; 8-pole; 2,50 mm²; gray



Item No.: 2002-559
Modular TOPJOB®S connector; modular; for jumper contact slot; 9-pole; 2,50 mm²; gray



Item No.: 2002-549
Spacer module; modular; e.g., for bridging commoned terminal blocks; gray



Item No.: 2009-174
Test plug adapter; for 4 mm Ø test plugs; for testing TOPJOB®S rail-mounted terminal blocks; gray



Item No.: 2009-182
Testing tap; for max. 2.5 mm²; tool-free connection for individual test wires 0.08 - 2.5 mm; gray



Item No.: 2002-649
TOPJOB®S L-type spacer module; modular; e.g., for bridging commoned terminal blocks; gray



Item No.: 2002-611
TOPJOB®S L-type test plug module; modular; 1-pole; 2,50 mm²; gray

1.2.12 Tool

1.2.12.1 Operating tool



Item No.: 210-658
Operating tool; Blade: 3.5 x 0.5 mm; with a partially insulated shaft; angled; short; multicoloured



Item No.: 210-720
Operating tool; Blade: 3.5 x 0.5 mm; with a partially insulated shaft; multicoloured

Installation Notes

Conductor termination



All conductor types at a glance

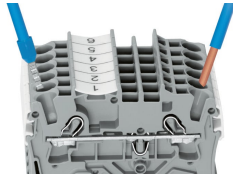

Push-in termination of solid and ferruled conductors

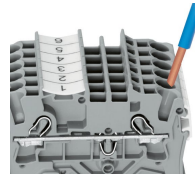

Inserting a conductor via push-in termination:
Solid conductors with cross-sections from either one size above, or up to two sizes below, the rated cross-section can be simply pushed in – no tools needed.

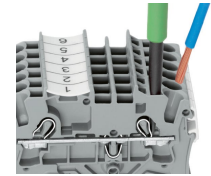

Inserting a conductor via operating tool:
Connecting fine-stranded conductors without ferrules, or small cross-sectional conductors that cannot be pushed in, is performed similarly to the original CAGE CLAMP® – just use an operating tool.
Advantage:
To open the clamp, the operating tool is inserted vertically. The conductor entry is less than 15 degrees for easier wiring.

Commoning

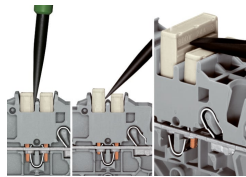
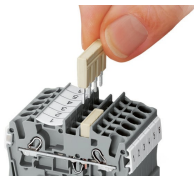

Insert push-in type jumper bar and push down until it hits backstop.

Removing a push-in type jumper bar: Insert the operating tool between the jumper and partition wall of the dual jumper slots, then lift up the jumper. Place the operating tool in the center of jumpers for up to five contacts (see above), or alternately on both sides for jumpers with more than five contacts.

Commoning

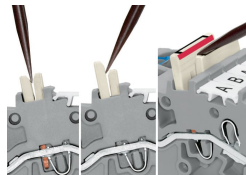
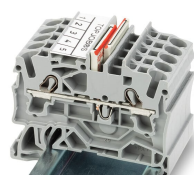

Orient the staggered jumpers' red stripes on the inside. Insert the staggered jumper and push down until it hits the backstop.

Removing a staggered jumper: Insert the operating tool between the staggered jumpers, then lift up the jumper.

Commoning

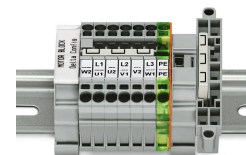
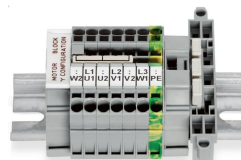
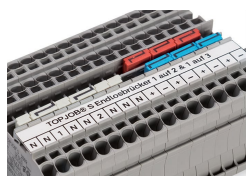
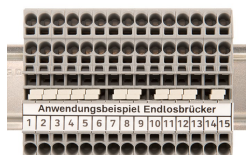

Continuous jumpers (2002 Series) readily connect an endless number of terminal blocks to each other via single jumper slot. Use the second jumper slot for additional commoning or testing.

The 1-to-3 adjacent jumper for continuous commoning enables every other terminal block to be commoned. For example, positive and negative potentials can be accommodated alongside each other.

This star point jumper has been specially developed to create a "star point" and is used on motor terminal boards equipped with Rail-Mount Terminal Blocks TOPJOB® S.

This delta jumper has been specially developed to create a delta configuration and is used on motor terminal boards equipped with rail-mount terminal blocks TOPJOB® S.

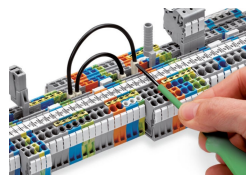

Push down the wire jumper until fully inserted. Lift the jumper with an operating tool for rewiring.

Commoning

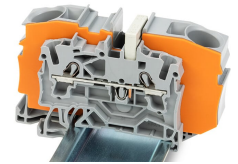
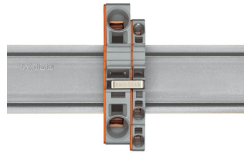
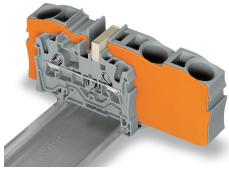

Step-down jumpers common terminal blocks of different sizes, without losing a conductor clamping point. This can be beneficial on long conductor runs where voltage drop can be a problem. A large conductor can be easily connected to smaller conductors at the distribution point. Commoning may be made in either direction using the special thin end plate to cover the open side. Additional through terminal blocks having a smaller cross-section may be commoned using push-in type jumper bars.

Using step-down jumpers, an end plate must be inserted between the terminal blocks to be commoned.

Step-down jumper (Item No. 2006-499) commons 6/4 mm² (10/12 AWG) terminal blocks (2006/2004 Series) with 4/2.5/1.5 mm² (AWG 12/14/16) terminal blocks (2004/2002/2001 Series).

Step-down jumper (Item No. 2016-499) commons 16/10 mm² (16/8 AWG) terminal blocks (2016/2010 Series) with 10/6/4/2.5 mm² (8/10/12/14 AWG) terminal blocks (2010/2006/2004/2002 Series).

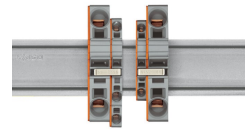
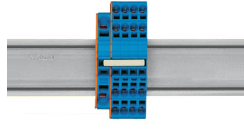
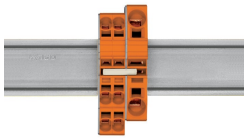

Stepping down via push-in type jumper bar: Commoning via open terminal side with end plate allows jumpering over two cross-section sizes for 16 mm² (6 AWG) and 10 mm² (8 AWG) and one cross-section size for 6/4/2.5 mm² (10/12/14 AWG). An example: from 16 mm² (6 AWG) to 6 mm² (10 AWG) (see illustration above) or from 10 mm² (8 AWG) to 4 mm² (12 AWG).

Stepping down via push-in type jumper bar: Commoning via closed terminal side with end plate allows jumpering over two cross-section sizes, e.g., from 16 mm² (6 AWG) to 6 mm² (10 AWG) or from 6 mm² (10 AWG) to 2.5 mm² (14 AWG) (see illustration above).

Note: The total current of the outgoing circuits must not exceed the nominal current of the step-down jumper/push-in type jumper bar.

Testing

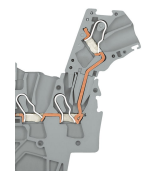
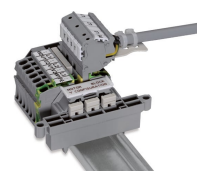
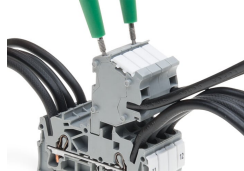

The modular TOPJOB® S connectors also connect conductors of the same size as the terminal blocks being used.

TOPJOB® S Connectors with a 2 mm Ø test socket for testing voltage via 2-pole voltage tester

Rail-mount terminal block assembly for electric motor wiring

L-type test plug module – cross-sectional view of contacts



Test plug adapter (2009-174, CAT I) for 4 mm Ø plugs – compatible with 2000 to 2016 Series

Testing tap (2009-182) for tool-free connection of test cables up to 2.5 mm² (12 AWG) – compatible with 2000 to 2016 Series

Marking

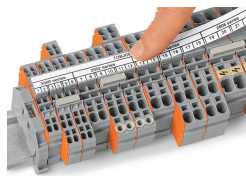
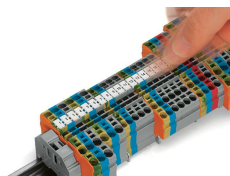

Snapping WMB Inline markers into marker slots.

TOPJOB® S 2009-193 Group Marker Carrier (equipped with a marking strip) for all 2001 to 2016 Series TOPJOB® S Rail-Mount Terminal Blocks
Do not use on an end plate!

Using marker carriers for marking strips (2002-161) in jumper slots.

Ex application

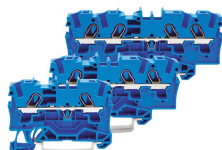
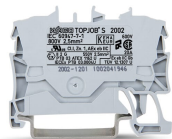

Through terminal blocks with a blue insulated housing are suitable for Ex i applications.

All through and ground conductor terminal blocks are suitable for Ex e II applications.

Separator plate for Ex e/Ex i applications

An end plate must be applied to the terminal block located directly behind an Ex e/Ex i separator plate.

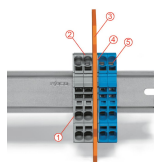

Ex e II/Ex i terminal strip

Note:
The movable feet of terminal blocks and separator plates must face the same direction.

A separator plate is located between the Ex e II and Ex i terminal strip.
End plate
Ex e II terminal blocks
Separator plate for Ex e/Ex i applications
End plate
Ex i terminal blocks
According to EN 50020, a minimum distance of 50 mm must be kept between live parts of Ex e and Ex i circuits. The use of Ex e/Ex i separators is a space-saving solution when Ex e and Ex i terminal blocks are mounted on a common DIN-rail.